

Plunger Pumps

Please read and save these instructions. Read carefully before attempting to assemble, install, operate or maintain the product described. Protect yourself and others by observing all safety information. Failure to comply with instructions could result in personal injury and/or property damage! Retain instructions for future reference.

Description

Plunger Pumps are designed for high-pressure industrial washing applications. They are constructed of die-cast bodies and feature a forged brass head with a bayonet style sight glass in the rear and side covers. Internal components include special solid ceramic plungers for long life and durability. Precision cast cooling fins are anodized for maximum heat dissipation. Oversized premium tapered roller bearings and the precision supports assure proper shaft alignment and maximum life. Valve cages of special designed Ultra-Form provide positive seating and extended life. Two-piece connecting rods are a special alloy aluminum-based material oversized for strength and load disbursement. These pumps are designed for gearbox, belt drive, or flex coupled systems, with a 24mm solid crankshaft.

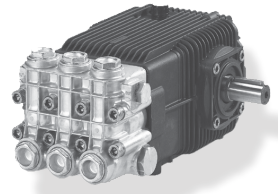

Figure 1

XW 1450 rpm N Version

Model	Max GPM	Max PSI
XW-M15.30	3.96	4350
XW-M21.28	5.55	4060
XW-M26.20	6.87	2900
XW30.25	7.92	3600

XWL 1450 rpm N Version

Model	Max GPM	Max PSI
XWL42.15N	11.09	2200

XWLA 1750 rpm N Version

Model	Max GPM	Max PSI
XWLA13G15N	13.0	1450

XWA 1750 rpm N Version

Model	Max GPM	Max PSI
XWA-M4G40N	4.0	4000
XWA-M5.5G40N	5.5	4000
XWA-M7G40N	7.0	4000
XWA-M8G35N	8.0	3500
XWA9G24N	9.0	2400

XWT 500 rpm N Version

Model	Max GPM	Max PSI
XWT21.20N	5.55	2900

XWF 1000 rpm N Version

Model	Max GPM	Max PSI
XWF26.06N	6.87	900
XWF30.20N	7.92	2900
XWF36.17N	9.51	2500

Plunger Pumps

XWT / XWF / XWL / XWLA N version
Solid shaft pump \varnothing 24 mm

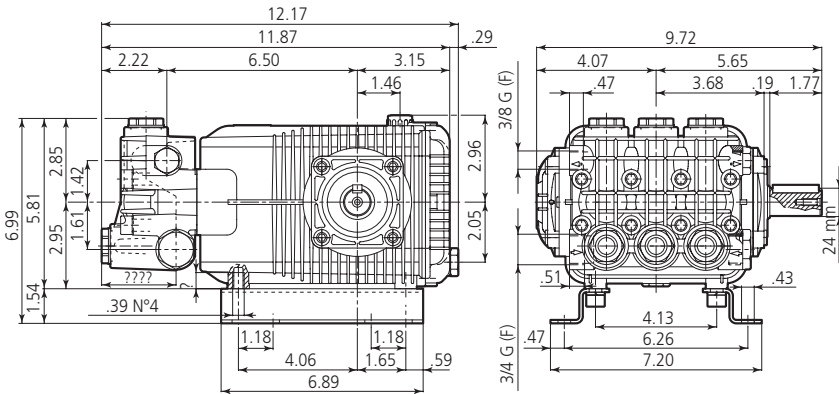

Plunger Pumps

<i>Formulas</i>	<i>Conversions</i>
-----------------	--------------------

Nozzles:

Impact Force (lbs.) = .0526 x GPM x $\sqrt{\text{PSI}}$

Nozzle # = $\text{GPM} \times \frac{4000}{\sqrt{\text{PSI}}}$

GPM = $\text{Nozzle \#} \times \frac{\text{PSI}}{\sqrt{4000}}$

PSI = $(\text{GPM}/\text{Nozzle \#})^2 \times 4000$

Horse Power:

$\frac{\text{GPM} \times \text{PSI}}{1714}$ = Hydraulic HP

$\frac{\text{GPM} \times \text{PSI}}{1457}$ = EBHP

$\frac{\text{EBHP} \times 1457}{\text{PSI}}$ = GPM

$\frac{\text{EBHP} \times 1457}{\text{GPM}}$ = PSI

HP loss due to altitude = 3% per 1000 FT above sea level

Pump Speed and Flow:

$\frac{\text{Rated GPM}}{\text{Rated RPM}} = \frac{\text{Desired GPM}}{\text{Desired RPM}}$

$\frac{\text{Motor Pulley } \varnothing}{\text{Pump RPM}} = \frac{\text{Pump Pulley } \varnothing}{\text{Motor RPM}}$

Gallons x 3.785412 = Liters

Gallons x 128 = Oz.

PSI x .06896 = Bar

Bar x 14.5038 = PSI

1 inches = 25.4 millimeters

Liters x .2642 = Gallons (US)

Ft. Lbs. x 1.356 = Newton Meters

Inch Lbs. x .11298 = Newton Meters

Newton Meters x .737562 = Ft. Lbs. (force)

Newton Meters x 8.85 = In. Lbs. (force)

Temperature = $1.8(\text{C}^\circ + 17.78) = \text{F}^\circ$, $.555(\text{F}^\circ - 32) = \text{C}^\circ$

1 U.S. Gallon of freshwater = 8.33 lbs.

1 PSI = 2.31 feet of water

1 PSI = 2.04 inches of mercury

1 Foot of water = .433 PSI

1 Foot of water = .885 inches of mercury

1 Meter of water = 3.28 feet of water

Kilograms x 2.2 = Lbs.

General Safety Information



WARNINGS

Gasoline Drive Pumps

 The pump is designed to pump non-flammable or non-explosive fluids.

These pumps are intended to pump clean filtered water only.

 Do not operate in or around an explosive environment.

  Always wear safety glasses or goggles and appropriate clothing.

 Do not alter the pump from the manufacturers design.

 Do not allow children to operate the pump.

 Never point the high-pressure discharge at a person, any part of the body or animals.

Do not operate gasoline engines in a confined area; always have adequate ventilation.

 Do not exceed the pump specifications in speed or pressure.

Plunger Pumps

General Safety Information (continued)

 Maximum water temperature is 140°F.

All positive displacement plunger pumps must have a safety relief valve installed on the discharge side of the pump, this valve could be either an unloader or regulator and must be of adequate flow and pressure for the pump.

Adequate protective guards must cover all moving parts. Perform routine maintenance on the pump and components.

Use only components that are rated for the flow and pressure of the pump, this would include hose, fittings, safety valves, spray guns etc.

Electric Drive Pumps

Your power supply must conform to the system requirements.

 The motor must be grounded. Use GFCI plugs and receivers.

 Do not handle the pump/motor with wet hands.

 Only use power cords that are in good condition.

 Never pull the unit by the power cord.

Never spray or clean the unit with water

Failure to follow these warnings may result in personal injury or damage to property.

Special Features

Wet End

Manifold: Forged Brass: Strength and no porosity – long life. Higher hydrostatic pressures – safety, performance. **Inlet and Discharge Ports:** Heavy bosses for added strength. **Offset Discharge Ports:** High efficiency, smooth flow. **Bolts:** Eight bolts, 10mm, grade 8.8.

Valves: Ultra Form Cages: Durable, strength, and long life. **Poppets, Seat and Spring:** 303 and 400 series stainless steel. **Valve Caps:** Forged.

Packing and Plungers: High Pressure Packing: “V” style (D-1) Buna-N (cotton duct weave base) strong and tightens under load. **Low Pressure Seals:** “U” cup double lip Buna-N for a good positive seat. **Support and Guides:** Machined brass, 2-piece construction to assure proper plunger alignment and to maximize packing and seal life. **Plungers:** Are a special aluminum oxide blend, solid ceramic for long life, strong durability and more resilient.

Drive End

Bearings: Oversized for maximum life and load disbursement

Bearing Support: Precision die-cast and machined to assure concentricity and alignment.

Crankcase: Precision die-cast, large cross head for strength, large cooling fins and anodized (for maximum heat dissipation).

Plunger Pumps

Special Features (continued)

Rear Cover: Precision die-cast, O-ring sealed and bayonet style sight glass for positive sealing and locking (no threads to loosen).

Plunger Rods: Stainless steel construction for strength (no plating to scrape off), back-up and O-ring plunger sealing system.

Rod Pins: Precision ground and hardened steel, oversized for load disbursement.

Connecting Rods: Heavy 2-piece special alloy aluminum based, oversized for maximum strength, load disbursement, and life. Heavy pin area construction, for added load strength.

Crankshaft: Forged, precision ground and hardened for extremely long life and durability.

Oil Seals and O-rings: All are constructed of Buna-N rubber. The O-rings have stainless steel garter springs to assure constant tension on the sealing surface.

Oil Capacity: 32 oz., refer to parts breakdown.

Extra Features

Dyno Proven: All pumps are dyno tested to assure the theoretical design meets the actual design.

Valve Design: Each pump series has a valve design that optimizes its highest efficiency.

Hot Water: High temperature kits are available to 180°F. Refer to breakdown.

Wet End Repair: Very simple no special tools required.

Design: Using advanced fluid handling design programs. Overall pump efficiency is increased.

Installation

Belt Drive Systems

1. Mount the pump securely to the base plate. (See Figure 2) For new installation a mounting rail kit is required, refer to breakdown.

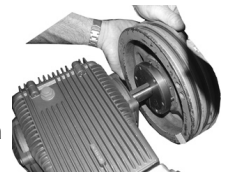

Figure 2

2. Install the pump pulley on the crankshaft. It should be as far onto the shaft as possible.
3. Align the pulleys so they are in line. (See Figure 3)



Figure 3

4. Use a belt tension gauge to assure proper tension (too much tension can cause bearing failure or damage the belts as well as cause other problems). (See Figure 4)

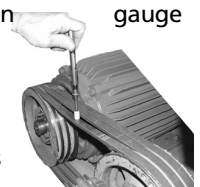

Figure 4

5. Installation complete.

Winter or Long Time Storage

1. Drain all of the water out of the pump.

Plunger Pumps

Winter or Long Time Storage (continued)

2. Run a 50% solution of a RV or non-toxic/biodegradable antifreeze through the pump.
3. Flush the pump with fresh water before the next use.
4. In freezing conditions failure to do this may cause internal pump damage.
5. For long periods of storage in non-freezing areas the solution will keep the seals and O-rings lubricated.

Service Pumps

Servicing the Valves

The inlet and discharge valves in this series pumps are all the same. The valves are located under the six 27mm hex plugs. The inlet valves are located on the lower row and the discharge valves are located on the top row of the pump head.

Tools required: 27mm socket, ratchet, needle nose pliers, mechanics pick and torque wrench.

Valve Removal:

1. Remove the valve cap. (See Figure 5)
2. Inspect the valve cap O-ring for any damage, replace if necessary. (See Figure 6)



Figure 5



Figure 6

3. Use the needle nose pliers to remove the valve. (See Figure 7)
4. Use a small probe to move the poppet up and down to assure that the valve is functioning properly and that no debris is stuck in the valve.
5. Using the mechanics pick remove the valve seat O-ring and inspect for any damage, replace if necessary.



Figure 7

Valve Assembly:

1. Install the valve seat O-ring squarely into the bottom of the manifold. (See Figure 8)
2. Insert the valve assembly squarely into the port pushing it into the O-ring.
3. Install the valve cap and torque to the proper specification. (See Figure 9)



Figure 8



Figure 9

Servicing the Packings/Seals

To access the water seals for inspection or replacement, you will first need to remove the head of the pump.

Tools required: 8mm hex socket, ratchet, (2) long screwdrivers, reversible pliers, mechanics pick and torque wrench.

Plunger Pumps

Service Pumps (continued)

Disassembly:

1. First remove the eight 8mm head bolts.
2. Place the screwdrivers as shown between the head and crankcase of the pump, lifting one up and the other down. The head should start to lift off of the plungers. (See Figure 10)



Figure 10

3. When you remove the head you may notice that some of the water seals have stayed on the plungers and some in the head. To remove the seals from the plungers simply turn the assemblies and pull off. (See Figure 11)

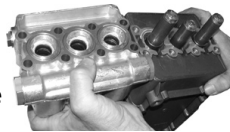

Figure 11

4. If the seal assemblies are in the head use the reversible pliers to grab the seal retainer on the inside of the outside ring, twist the retainer in either direction (this is done to free the retainer O-ring which is stuck to the manifold) and lift out. (See Figure 12)



Figure 12

5. With your finger pull out the brass intermediate guide ring. (See Figure 13)



Figure 13

6. With your fingers pull the high-pressure seal and head ring out of the head. (See Figure 14)



Figure 14

7. The low-pressure seal is located in the brass seal retainer. Using the mechanics pick, go in between the seal and retainer and pull the seal straight out. **NOTE:** Models have a split support O-ring. (See Figure 15)



Figure 15

8. Remove the seal retainer O-ring with the mechanics pick.

Assembly:

1. Install the plastic head ring into the head (the flat side is on the bottom).

2. Install the high-pressure seal. Place the seal so the open "V" portion is toward the head ring. You need to place the seal at an angle and pull and push to work the seal into position



Figure 16

Plunger Pumps

Service Pumps (continued)

with your fingers (do not use any tools you may damage the seal). Make sure the seal is totally seated against the head ring. (See Figure 16 & 17)

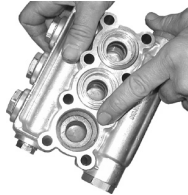

Figure 17

3. Place the brass intermediate ring squarely over the high-pressure seal.



Figure 18

4. Installing the low-pressure seal with the closed flat side of the seal being pushed into the piston guide (when finished you should be looking at the open side of the seal). Install split O-ring (Hold in place with light grease). (See Figure 18)

5. Install the retainer O-ring.



Figure 19

6. Squarely seat the retainer into the head and push with even pressure until it snaps into position. (See Figure 19)

Servicing the Plungers

If the plungers are not damaged they do not need any servicing.

Tools required: 17mm socket, ratchet, mechanics pick, taper blade gasket scraper, thread sealant and torque wrench.

NOTE: Be very careful when working with the plungers, they are made from ceramic which is brittle and can be damaged.

Any time you remove a plunger it is recommended you replace the slinger washer, O-ring and top plunger washer. The washers are a cushion for the ceramic plunger and compress when first used, O-ring will set to create a seal and usually will not spring back to its original shape. By not replacing these parts you run the risk of breaking a plunger or having a water leak.

Disassembly:

1. Remove the plunger retainer nut. (See Figure 20)

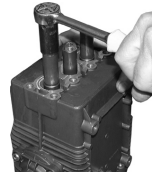

Figure 20

2. Insert the gasket scraper between the copper washer and plunger to remove the washer. (See Figure 21)

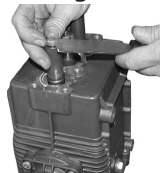

Figure 21

3. Twist and pull the plunger off the plunger rod. (See Figure 22)



Figure 22

4. Remove the plunger rod O-ring seal and split back-up ring with the mechanics pick.

5. Remove the brass slinger. At this point clean any thread locker that is left on the plunger rod and retaining nut threads.

Plunger Pumps

Assembly:

1. Install the slinger washer.
2. Install the plunger rod O-ring and split back-up ring. Place a light film of oil on the O-ring and back-up ring. **NOTE:** The O-ring is closest to the threaded end of the rod.
3. Install the plunger by pushing straight down and twisting slightly in either direction. Make sure you fully seat the plunger. (See Figure 23)



Figure 23

4. Install the small copper washer on top of the plunger and place a small quantity of thread sealant in the thread. Install the plunger nut and tighten to the required torque. (See Figure 24)



Figure 24

3. Torque the head bolt as shown in the tightening sequence diagram. (See Figure 27 & 28)



Figure 27



Figure 28

Oil Change

Change oil after first 50 hours of use. Then every 500 hours. Refer to parts breakdown for oil type.

Pump Head to Drive End Installation

1. Turn the crankshaft to align the plungers as shown. (See Figure 25)
2. Place the head evenly onto the plungers and push it until it makes contact with the drive end of the pump. (See Figure 26)

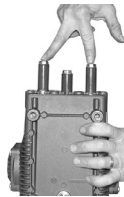

Figure 25



Figure 26

Troubleshooting

Symptom	Possible Cause(s)	Corrective Action
Oil leak between crankcase and pumping section	Worn rod oil seals	Replace crankcase piston rod seals
Frequent or premature failure of the packing	1 Cracked, damaged or worn plunger	1 Replace plungers
	2 Overpressure to inlet manifold	2 Reduce inlet pressure
	3 Material in the fluid being pumped	3 Install proper filtration on pump inlet plumbing
	4 Excessive pressure and/or temperature of fluid being pumped	4 Check pressures and fluid inlet temperature; be sure they are within specified range
	5 Running pump dry	5 Do not run pump without water
Pump runs but produces no flow	Pump is not primed	Flood suction then restart pump
Pump fails to prime	Air is trapped inside pump	Disconnect discharge hose from pump. Flood suction hose, restart pump and run pump until all air has been evacuated
Pump loses prime, chattering noise, pressure fluctuates	1 Air leak in suction hose or inlet	1 Remove suction line and inspect it for a loose liner or debris lodged in hose. Avoid all unnecessary bends. Do not kink hose
	2 Clogged suction strainer	2 Clean strainer
Low pressure at nozzle	1 Unloader valve is by-passing	1 Make sure unloader is adjusted properly and by-pass seat is not leaking
	2 Incorrect or worn nozzle	2 Make sure nozzle is matched to the flow and pressure of the pump. If the nozzle is worn, replace
	3 Worn packing or valves	3 Replace packing or valves
Pressure gauge fluctuates	1 Valves worn or blocked by foreign bodies	1 Clean or replace valves
	2 Packing worn	2 Replace packing
Low pressure	1 Worn nozzle	1 Replace with nozzle of proper size
	2 Belt slippage	2 Tighten or replace with correct belt

Troubleshooting (cont.)

Symptom	Possible Cause(s)	Corrective Action
Low pressure (cont.)	3 Air leak in inlet plumbing	3 Disassemble, reseal and reassemble
	4 Relief valve stuck, partially plugged or improperly adjusted valve seat worn	4 Clean and adjust relief valve; check for worn or dirty valve seats
	5 Worn packing. Abrasive in pumped in cavitation. Inadequate water	5 Install proper filter suction at inlet manifold must be limited to lifting less than 20 feet of water or 8.5 psi vacuum
	6 Worn inlet, discharge valve blocked or dirty	6 Replace inlet and discharge valve
Pump runs extremely rough, pressure very low	1 Inlet restrictions and/or air leaks.	1 Clean out foreign material
	2 Stuck inlet or discharge valve	2 Replace worn valves
Water leakage from under manifold	Worn packing or cracked plunger	Install new packing or plunger
Slight leak, oil leaking in the area of crankshaft	1 Worn crankshaft seal or improperly installed oil seal o-ring	1 Remove oil seal retainer and replace damaged O-ring and/or seals
	2 Bad bearing	2 Replace bearing
Excessive play in the end of the crankshaft pulley	Worn main bearing from excessive tension on drive belt	Replace crankcase bearing and/or tension drive belt
Water in crankcase	1 Humid air condensing into water inside the crankcase	1 Change oil intervals
	2 Worn packing and/or cracked plunger	2 Replace packing. Replace plunger
Loud knocking noise in pump	1 Cavitation or sucking air	1 Check water supply is turned on
	2 Pulley loose on crankshaft	2 Check key and tighten set screw
	3 Broken or worn bearing	3 Replace bearing

XW 1450 RPM

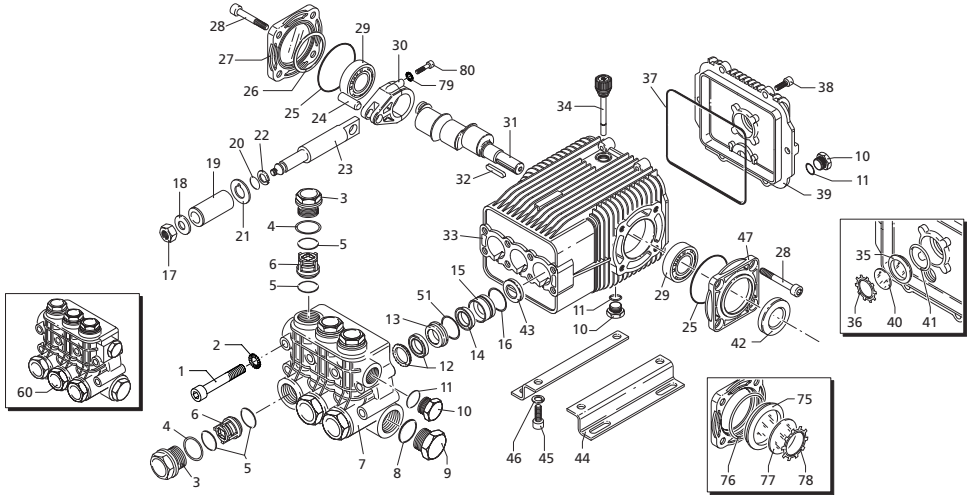

Repair Kits

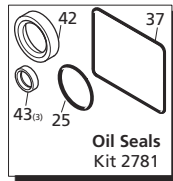
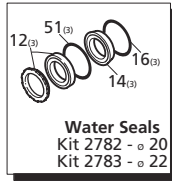
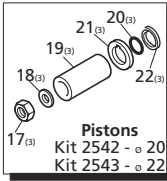
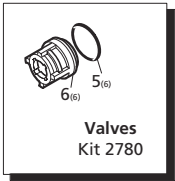

Special Parts / Kits

Code	Description	Qty.
2778	Viton water seals ø20	1
2779	Viton water seals ø22	1
980069	Packing extractor	1
2748	Rail kit 1-1/4" - 2 Rails - 4 Bolts - 4 Washers	1

Pos.	Code	Description	Qty.	Pos.	Code	Description	Qty.
1	1940260	Head bolt M10x80	(442 in/lbs) 8	28	850370	Bolt M8x16	(217 in/lbs) 8
2	650530	Washer	8	29	1941370	Bearing	● 2
3	1940140	Valve cap	(602 in/lbs) 6	30	1140410	Bearing	○■▲ 2
3	1941970	Valve cap 1/4" threaded	(602 in/lbs) 1	31	1940050	Con-rod	(89 in/lbs) 3
4	1940150	Ring	6	31	1940520	Crankshaft 24mm	● 1
5	1140450	O-Ring ø20.24x2.62	12	31	1940180	Crankshaft 24mm	○ 1
6	1949050	Complete valve	6	31	1940160	Crankshaft 24mm	■▲ 1
7	1940021	Pump head	●○■ 1	32	650250	Key	1
7	1941210	Pump head	▲ 1	33	1941330	Pump housing	1
8	550350	O-Ring ø23.81x2.62	1	34	1140370	Vented oil cap	1
9	1140300	Plug 3/4" G	1	35	1260250	Oil sight glass	1
10	1980740	Plug 3/8" G	3	36	1260430	Snap ring	1
11	740290	O-Ring ø14x1.78	3	37	1940410	O-Ring ø132x3	1
12	1940440	High pressure packing w/ring ø20	3	38	1200430	Bolt M6x16	(89 in/lbs) 6
13	1940270	High pressure packing w/ring ø22	3	39	1949010	Compete cover	1
13	1940430	Front piston guide ø20	3	40	1780690	Contrast disc	1
14	1940200	Front piston guide ø22	3	41	1140450	O-Ring ø20.24x2.62	1
14	1940470	Low pressure seal ø20	3	42	820680	Oil seal	1
15	1940480	Low pressure seal ø22	3	43	1940560	Oil seal	3
15	1940450	Rear piston guide ø20	3	44	1940370	Rail 1-1/4"	2
15	1940460	Rear piston guide ø22	3	45	1940380	Bolt	4
16	820490	O-Ring ø34.65x1.78	3	46	200231	Washer	4
17	1940570	Nut (106 in/lbs)	3	47	1941240	Open bearing support	1
18	1940580	Washer - Copper	3	51	1941220	Slit O-Ring	3
19	1420430	Piston ø20	3	60	1949200	Complete pump head ø20	1
19	1420120	Piston ø22	3	60	1949203	Complete pump head ø22	1
20	880840	O-Ring ø9.25x1.78	3	75	1941270	Oil sight glass	1
21	960460	Slinger	3	76	100410	O-Ring ø34.6x2.62	1
22	1940120	Back-up ring	3	77	1941260	Contrast disc	1
23	1940070	Guiding piston	3	78	1941290	Seal	1
24	1940060	Piston pin	3	79	1380510	Con-rod bolt	6
25	1941380	O-Ring ø66.34x2.62	2	80	1381550	Lockwasher	6
26	1941390	Shim 0.05 mm	1-3				
26	1941400	Shim 0.10 mm	1-3				
26	1941410	Shim 0.19 mm	1-3				
26	1941420	Shim 0.25 mm	1-3				
27	1949011	Side cover w/sight glass	1				

Legend

ø 20	ø 20	ø 20	ø 22
For ●	For ○	For ■	For ▲
XW15.15	XW21.20	XW26.12	XW30.10
XW15.20	XW21.25	XW26.15	XW30.15
XW15.30	XW21.28	XW26.20	XW30.20
		XW26.23	XW30.25

AR64516 Oil 2
OIL CAPACITY - 32 OZ

XW-M 1450 RPM

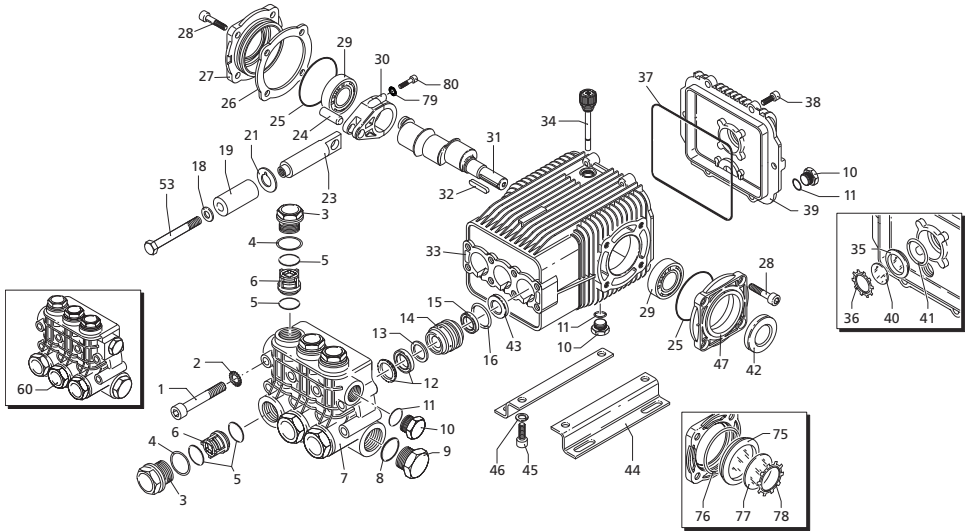

Repair Kits

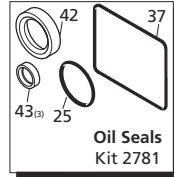
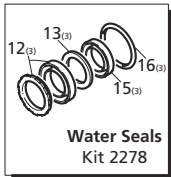
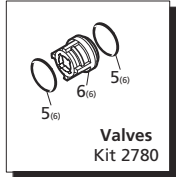

Special Parts / Kits

Code	Description	Qty.
980069	Packing extractor	1
2748	Rail kit 1-1/4" - 2 Rails - 4 Bolts - 4 Washers	1

Pos.	Code	Description	Qty.	Pos.	Code	Description	Qty.
1	1940260	Head bolt M10x80	(442 in/lbs) 8	37	1940410	O-Ring ϕ 132x3	1
2	650530	Lockwasher	8	38	1200430	Bolt M6x16	(89 in/lbs) 6
3	1940140	Valve cap	(602 in/lbs) 6	39	1949010	Compete cover	1
4	1940150	Ring	6	40	1780690	Contrast disc	1
5	1140450	O-Ring ϕ 20.24x2.62	12	41	1140450	O-Ring ϕ 20.24x2.62	1
6	1949050	Complete valve	6	42	820680	Seal ring	1
7	1940021	Pump head	1	43	1940560	Seal	3
8	550350	O-Ring ϕ 23.81x2.62	1	44	1940370	Rail 1-1/4"	2
9	1140300	Plug 3/4" G	1	45	1940380	Bolt	4
10	1980740	Plug 3/8" G	3	46	200231	Washer	4
11	740290	O-Ring ϕ 14x1.78	3	47	1941240	Open bearing support	1
12	1940440	Gasket w/ring	3	53	1941640	Bolt M6x60	3
13	1940430	Front piston guide	3	60	1949216	Complete pump head	1
14	1942410	Piston guide	3	75	1941270	Oil sight glass	1
15	840280	Gasket	3	76	100410	O-Ring ϕ 34.6x2.62	1
16	820490	O-Ring ϕ 34.65x1.78	3	77	1941260	Contrast disc	1
18	1340600	Washer - Copper	3	78	1941290	Seal	1
19	1942330	Piston	3	79	1380510	Lockwasher	6
21	1383190	Spacer	3	80	1381550	Con-rod bolt	6
23	1940960	Guiding piston	3		AR64516	Oil	2
24	1940060	Piston pin	3			<i>OIL CAPACITY - 32 OZ</i>	
25	1941380	O-Ring ϕ 66.34x2.62	2				
26	1941390	Shim 0.05 mm	1-3				
26	1941400	Shim 0.10 mm	1-3				
26	1941410	Shim 0.19 mm	1-3				
26	1941420	Shim 0.25 mm	1-3				
27	1949011	Side cover w/sight glass	1				
28	850370	Bolt M8x16	(217 in/lbs) 8				
29	1140410	Bearing	2				
30	1940050	Con-rod	(89 in/lbs) 3				
31	1940180	Crankshaft 24mm	■ 1				
31	1940520	Crankshaft 24mm	● 1				
32	650250	Key	1				
33	1941330	Pump housing	1				
34	1140370	Oil cap	1				
35	1260250	Oil sight glass	1				
36	1260430	Snap ring	1				

Legend

Ø 20

For ●
XW-M15.30

Ø 20

For ■
XW-M21.28

XWA 1750 RPM

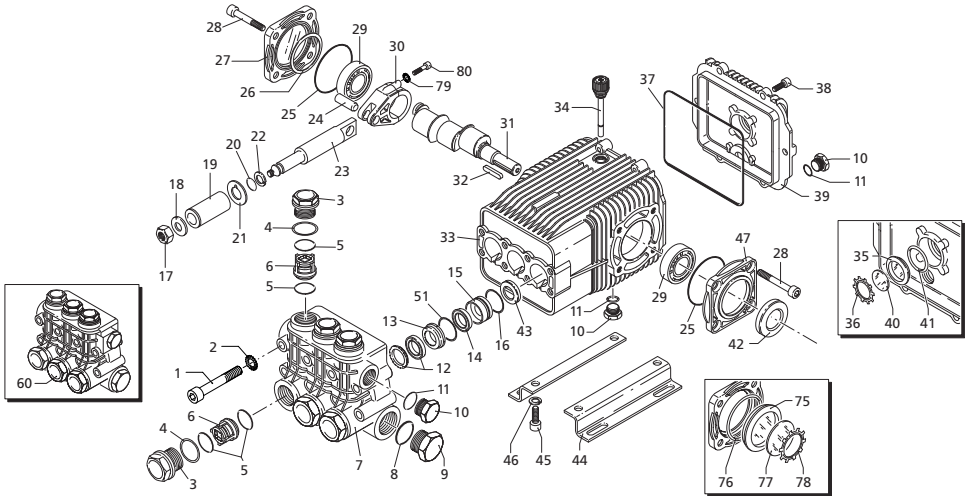

Repair Kits

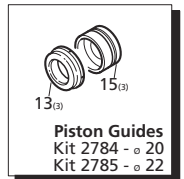
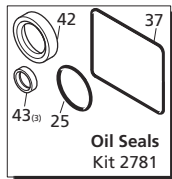
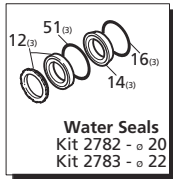
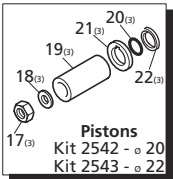
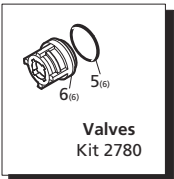

Special Parts / Kits

Code	Description	Qty.
2778	Viton water seals ø20	1
2779	Viton water seals ø22	1
980069	Packing extractor	1
2748	Rail kit 1-1/4" - 2 Rails - 4 Bolts - 4 Washers	1

Pos.	Code	Description	Qty.	Pos.	Code	Description	Qty.
1	1940260	Head bolt M10x80	(442 in/lbs) 8	28	850370	Bolt M8x16	(217 in/lbs) 8
2	650530	Washer	8	29	1140410	Bearing	2
3	1940140	Valve cap	(602 in/lbs) 6	30	1940050	Con-rod	(89 in/lbs) 3
3	1941970	Valve cap 1/4" threaded	(602 in/lbs) 1	1	1940530	Crankshaft 24mm	● 1
4	1940150	Ring	6	1	1940190	Crankshaft 24mm	○ 1
5	1140450	O-Ring ø20.24x2.62	12	1	1940170	Crankshaft 24mm	■ 1
6	1949050	Complete valve	6	1	1940160	Crankshaft 24mm	▲◆ 1
7	1940021	Pump head	●○■ 1	32	650250	Key	1
7	1941210	Pump head	▲◆ 1	33	1941330	Pump housing	1
8	550350	O-Ring ø23.81x2.62	1	34	1140370	Vented oil cap	1
9	1140300	Plug 3/4" G	1	35	1260250	Oil sight glass	1
10	1980740	Plug 3/8" G	3	36	1260430	Snap ring	1
11	740290	O-Ring ø14x1.78	3	37	1940410	O-Ring ø132x3	1
12	1940440	High pressure packing w/ring ø20 3	38	38	1200430	Bolt M6x16	(89 in/lbs) 6
12	1940270	High pressure packing w/ring ø22 3	39	39	1949010	Compete cover	1
13	1940430	Front piston guide ø20 3	40	40	1780690	Contrast disc	1
13	1940200	Front piston guide ø22 3	41	41	1140450	O-Ring ø20.24x2.62	1
14	1940470	Low pressure seal ø20 3	42	42	820680	Oil seal	1
14	1940480	Low pressure seal ø22 3	43	43	1940560	Oil seal	3
15	1940450	Rear piston guide ø20 3	44	44	1940370	Rail 1-1/4"	2
15	1940460	Rear piston guide ø22 3	45	45	1940380	Bolt	4
16	820490	O-Ring ø34.65x1.78	3	46	200231	Washer	4
17	1940570	Nut (106 in/lbs) 3	47	47	1941240	Open bearing support	1
18	1940580	Washer - Copper 3	51	51	1941220	Split O-Ring	3
19	1420430	Piston ø20 3	1	1949200	Complete pump head ●○■▲ 1		
19	1420120	Piston ø22 3	1	1949202	Complete pump head ▲ 1		
20	880840	O-Ring ø9.25x1.78	3	1949203	Complete pump head ◆ 1		
21	960460	Slinger 3	75	1941270	Oil sight glass	1	
22	1940120	Back-up ring 3	76	76	100410	O-Ring ø34.6x2.62	1
23	1940070	Guiding piston 3	77	77	1941260	Contrast disc	1
24	1940060	Piston pin 3	78	78	1941290	Seal	1
25	1941380	O-Ring ø66.34x2.62	2	79	1380510	Lockwasher	6
26	1941390	Shim 0.05 mm 1-3	80	80	1381550	Con-rod bolt	6
26	1941400	Shim 0.10 mm 1-3					
26	1941410	Shim 0.19 mm 1-3					
26	1941420	Shim 0.25 mm 1-3					
27	1949011	Side cover w/sight glass	1		AR64516	Oil	2

OIL CAPACITY - 32 OZ

Legend

ø 20

For ●
XWA4G20
XWA4G30
XWA4G40

ø 20

For ■
XWA7G22
XWA7G32
XWA7G35
XWA7G40

ø 20

For ▲
XWA8G19
XWA8G29
XWA8G35

ø 22

For ◆
XWA9G16
XWA9G24
XWA9G30

For ○
XWA5.5G22
XWA5.5G30
XWA5.5G40

XWA-M 1750 RPM

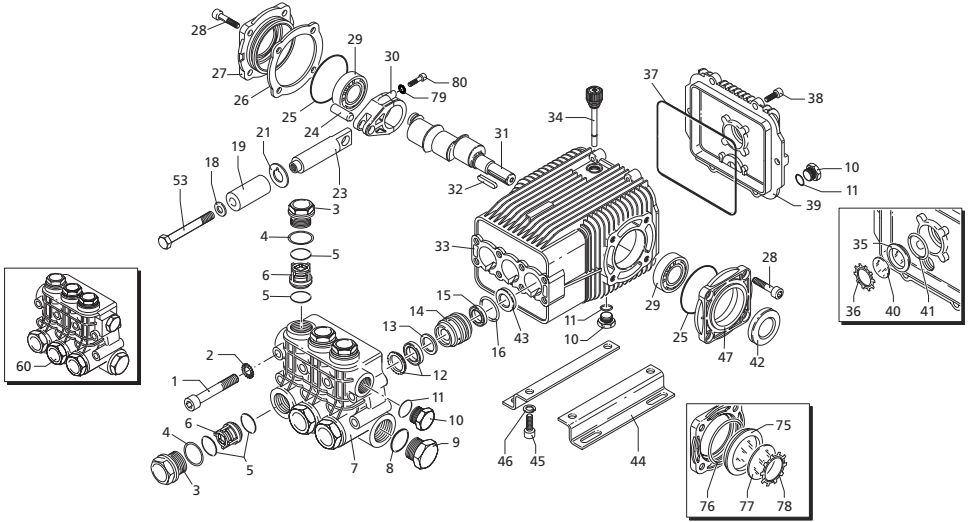

Repair Kits

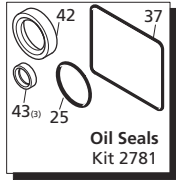
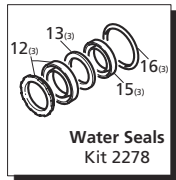
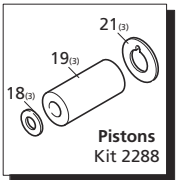
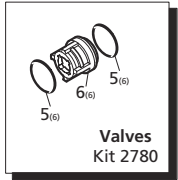

Special Parts / Kits

Code	Description	Qty.
980069	Packing extractor	1
2748	Rail kit 1-1/4" - 2 Rails - 4 Bolts - 4 Washers	1

Pos.	Code	Description	Qty.	Pos.	Code	Description	Qty.
1	1940260	Head bolt M10x80	(442 in/lbs) 8	34	1140370	Oil cap	1
2	650530	Lockwasher	8	35	1260250	Oil sight glass	1
3	1940140	Valve cap	(602 in/lbs) 6	36	1260430	Snap ring	1
4	1940150	Ring	6	37	1940410	O-Ring ϕ 132x3	1
5	1140450	O-Ring ϕ 20.24x2.62	12	38	1200430	Bolt M6x16	(89 in/lbs) 6
6	1949050	Complete valve	6	39	1949010	Complete cover	1
7	1940021	Pump head	○● 1	40	1780690	Contrast disc	1
	1941210	Pump head	▲ 1	41	1140450	O-Ring ϕ 20.24x2.62	1
8	550350	O-Ring ϕ 23.81x2.62	1	42	820680	Seal ring	1
9	1140300	Plug 3/4" G	1	43	1940560	Seal	3
10	1980740	Plug 3/8" G	3	44	1940370	Rail 1-1/4"	2
11	740290	O-Ring ϕ 14x1.78	3	45	1940380	Bolt	4
12	1940440	Gasket w/ring	3	46	200231	Washer	4
13	1940430	Front piston guide	3	47	1941240	Open bearing support	1
14	1942410	Piston guide	3	53	1941940	Bolt M6x60	3
15	840280	Gasket	3	60	1949216	Complete pump head	○● 1
16	820490	O-Ring ϕ 34.65x1.78	3		1949217	Complete pump head	▲ 1
18	1340600	Washer - Copper	3	75	1941270	Oil sight glass	1
19	1942330	Piston	3	76	100410	O-Ring ϕ 34.6x2.62	1
21	1383190	Spacer	3	77	1941260	Contrast disc	1
23	1940960	Guiding piston	3	78	1941290	Seal	1
24	1940060	Piston pin	3	79	1380510	Con-rod bolt	6
25	1941380	O-Ring ϕ 66.34x2.62	2	80	1381550	Lockwasher	6
26	1941390	Shim 0.05 mm	1-3		AR64516	Oil	2
	1941400	Shim 0.10 mm	1-3		OIL CAPACITY - 32 OZ		
	1941410	Shim 0.19 mm	1-3				
	1941420	Shim 0.25 mm	1-3				
27	1949011	Side cover w/sight glass	1				
28	850370	Bolt M8x16	(217 in/lbs) 8				
29	1140410	Bearing	2				
30	1940050	Con-rod	(89 in/lbs) 3				
	1940180	Crankshaft 24mm	○ 1				
	1940160	Crankshaft 24mm	▲ 1				
	1940530	Crankshaft 24mm	● 1				
	1940170	Crankshaft 24mm	■ 1				
32	650250	Key	1				
33	1941330	Pump housing	1				

Legend

○ 20

For ○
XWA-M5.5G40

○ 20

For ▲
XWA-M8G29
XWA-M8G35

○ 20

For ●
XWA-M4G40

For ■
XWA-M7G40

XWT - XWF - XWL - XWLA

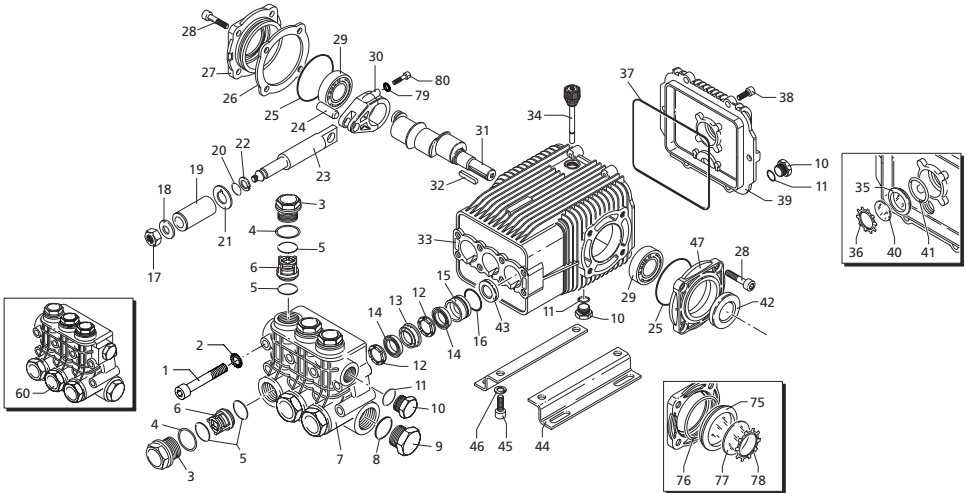

Repair Kits

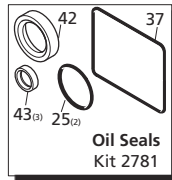
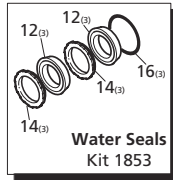
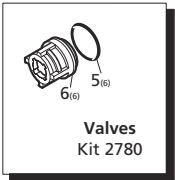

Special Parts / Kits

Code	Description	Qty.
2036	Viton water seals ø28	1
980069	Packing extractor	1
2748	Rail kit 1-1/4" - 2 Rails - 4 Bolts - 4 Washers	1

Pos.	Code	Description	Qty.	Pos.	Code	Description	Qty.	
1	1940260	Head bolt M10x80	(442 in/lbs) 8	29	1140410	Bearing	2	
2	650530	Washer	8	30	1940050	Con-rod	(89 in/lbs) 3	
3	1940140	Valve cap	(602 in/lbs) 6	31	1940160	Crankshaft 24mm	□ 1	
4	1941970	Valve cap 1/4" threaded	(602 in/lbs) 1	32	1940980	Crankshaft 24mm	○ 1	
5	1940150	Back-up ring	6	33	1940170	Crankshaft 24mm	● 1	
6	1140450	O-Ring ø20.24x2.62	12	34	650250	Key	1	
7	1949050	Complete valve	6	35	1941330	Pump housing	1	
8	1941550	Pump head	1	36	1140370	Vented oil cap	1	
9	550350	O-Ring ø23.81x2.62	1	37	1260250	Oil sight glass	1	
10	1140300	Plug 3/4" G	1	38	1260430	Snap ring	1	
11	1980740	Plug 3/8" G	3	39	1940410	O-Ring ø132x3	1	
12	740290	O-Ring ø14x1.78	3	40	1200430	Bolt M6x16	(89 in/lbs) 6	
13	1941570	Head ring	6	41	1949010	Rear cover	1	
14	1140280	Front plunger guide	3	42	1780690	Contrast disc	1	
15	820630	High & Low pressure packing	6	43	1140450	O-Ring ø20.24x2.62	1	
16	1941560	Rear plunger guide	3	44	820680	Oil seal	1	
17	1140490	O-Ring ø37.82x1.78	(106 in/lbs) 3	45	1940560	Oil seal	3	
18	1940570	Nut	3	46	1940370	Rail 1-1/4"	2	
19	1940580	Washer - Copper	3	47	1940380	Bolt	4	
20	1140190	Piston	3	48	200231	Washer	4	
21	880840	O-Ring ø9.25x1.78	3	49	1941240	Open bearing support	1	
22	1140160	Slinger	3	50	1949205	Complete pump head	1	
23	1940120	Ring	3	51	1941270	Oil sight glass	1	
24	1940070	Piston rod	3	52	100410	O-Ring ø34.6x2.62	1	
25	1940060	Connecting rod pin	3	53	1941260	Contrast disc	1	
26	1941380	O-Ring ø66.34x2.62	2	54	1941290	Seal	1	
27	1941390	Shim 0.05 mm	1-3	55	78	1941290	Seal	1
28	1941400	Shim 0.10 mm	1-3	56	1380510	Con-rod bolt	6	
	1941410	Shim 0.19 mm	1-3	57	1381550	Lockwasher	6	
	1941420	Shim 0.25 mm	1-3		AR64516	Oil	2	
	1949011	Side cover w/sight glass	1		<i>OIL CAPACITY - 32 OZ</i>			
	850370	Bolt M8x16	(217 in/lbs) 8					

Legend

ø 28	ø 28	ø 28	ø 28
For ○	For ■	For □	For ●
XWT21.28			
XWF26.06	XWF30.10	XWF26.17	XWF36.17
XWF26.09	XWF30.18		
XWF26.12	XWF30.20		
XWF26.15			
XWF26.20			
	XWL42.05		
	XWL42.07		
	XWL42.10		
	XWL42.15		
	XWLA13G15		

Plunger Pumps

Torque Specifications in/lbs:(ft/lbs)

Oil Capacity	Manifold (Head)	Piston Nut	Rear Cover	Side Cover	Valve Cap	Connecting Rods
32	442/(37)	106/(8.8)	89/(7.5)	217/(18)	602/(50)	89/(7.5)

LIMITED WARRANTY

Annovi Reverberi (A.R.) *Cam Shaft Plunger Pumps* are warranted for a period of five years and *Axial Radial Pumps* are warranted for a period of one year to the original purchaser. *Electric Pressure Washers* are warranted for a period of one year to the original purchaser. This is from the date shipped from factory or U.S. Warehouse. **AR, ArrowLine** and **GF** accessories are warranted for a period of 90 days.

Warranty covers manufacturing defects or workmanship that may develop under normal use and service in a manner up to the directions and usage recommended by the manufacturer.

Warranty does not apply to misuse or when pump or accessory is altered or used in excess of recommended speeds, pressures, temperatures or handling fluids not suitable for pump or accessory material construction. Warranty does not apply to normal wear, freight damage, freezing damage or damage caused by parts or accessories not supplied by AR North America, Inc.

Liability of manufacturer for warranty is limited to repair or replacement at the option of the manufacturer when such products are found to be of original defect or workmanship at the time it was shipped from factory. This warranty is in lieu of all other warranties, expressed or implied, including any warranty of merchantability and of any and all other obligations or liabilities on the part of the manufacturers or equipment.

WARRANTY RETURNS

Items returned for warranty consideration must have a **Returned Merchandise Authorization (RMA)** number. All unauthorized returns will be refused and shipped back to sender. Please fax requests to: 651-636-1424 or e-mail to shop@arnorthamerica.com.