

GB**WARRANTY**

Our products are guaranteed for a period of 12 months after the date of delivery. Warranty will not be acknowledged if the products are not used according to the manufacturer's instruction or are badly maintained. Always ask for original Spare-parts, otherwise warranty will not be acknowledged.

F**GARANTIE**

Nos produits sont garantis pour 12 mois à partir de la date de livraison. Aucune garantie ne sera reconnue, suite au mauvais entretien ou emploi anormal des produits. Pour tous vos besoins de pièces de rechange, demandez toujours les rechanges originaux. Au contraire, aucune garantie ne sera reconnue.

D**GARANTIE**

Die Firma gewährt eine Garantie von 12 Monaten, gerechnet vom Lieferdatum. Zweckfremder Einsatz und/oder nachlässige Wartung schließen jede Garantie aus. Im Bedarfsfall immer Original-Ersatzteile von der Firma anfordern. Anderenfalls kann keine Garantie gewährt werden.

E**GARANTÍA**

Nuestros productos están garantizados por 12 meses desde la fecha de la entrega. Ninguna garantía será reconocida por malo mantenimiento o por uso incorrecto de los productos. Pidan siempre repuestos originales. En caso contrario no se reconocerá ninguna garantía.

I**GARANZIA**

I nostri prodotti sono garantiti per mesi 12 dalla consegna. La Ditta si assume la responsabilità per tutti quei particolari che presentassero difetti di materiale o di lavorazione. Non è riconosciuta la garanzia per cattiva manutenzione, anomale impiego e per quelle parti non costruite dalla Ditta. Le riparazioni dovranno essere effettuate presso la fabbrica o da personale autorizzato. Nello stesso istante in cui i prodotti saranno manomessi da terzi, ogni garanzia sarà ritenuta scaduta. Per ogni verifica i prodotti dovranno essere inviati in Porto Franco. Nel caso di effettiva necessità di sostituzione di particolari sarà addebitato il solo costo della mano d'opera. Per il vostro fabbisogno di ricambi chiedete sempre ricambi originali. In caso diverso non sarà riconosciuta alcuna garanzia.





















Numero per ordini telefonici:

(+39) 059.414.411

Numero per ordini con fax:

(+39) 059.253.505

Prescrizioni per Montaggio**Prescription for Assembly**

	Avvitare con Loctite 2701 Frenaflettì FORTE (Verde) Screw down with Loxetal 83-21 STRONG (Green) thread sealer
	Incollare con Biadesivo acrilico VHB-3M 4945 Glue with VHB-3M 4945 acrylic biadhesive
	Sigillare con Arexons MOTOR-SIL D Seal with Arexons MOTOR-SIL D
	Sigillare con Arexons Mastic Seal with Arexons Mastic
	Sigillare con Loxetal 59-10 Seal with Loxetal 59-10
	Spruzzare un velo di Molykote D-321R Spray Spray on a light coat of Molykote D-321R
	Incollare con Loctite 454 Glue with Loctite 454
	Avvitare con Loxetal 24-18 Frenaflettì DEBOLE (Porpora) Screw down with Loxetal 24-18 WEAK (Purple) thread sealer
	Avvitare con Loxetal 55-14 Frenaflettì MEDIO (Rosso) Screw down with Loxetal 55-14 MEDIUM (Red) thread sealer
	Avvitare con Loxetal 83-21 Frenaflettì FORTE (Verde) Screw down with Loxetal 83-21 STRONG (Green) thread sealer
	Montare a caldo con RISCALDATORE Assemble hot with HEATER
	Montare con PRESSA Assemble with PRESS
	Lubrificare con GRASSO MINERALE Lubricate with MINERAL GREASE
	Lubrificare con OLIO MOTORE Lubricate with ENGINE OIL
	Coppia serraggio Tolleranza +0/-10% Nm Tightening torque tolerance +0/-10% Nm
	Lubrificare con GRASSO P40 Lubricate with P40 GREASE
	Lubrificare con GRASSO Molykote 1000 Lubricate with Molykote 1000 GREASE
	Lubrificare con GRASSO Molykote PG54 Lubricate with Molykote PG54 GREASE
	Avvitare con Loctite 5331 (Bianca) Screw down with Loctite 5331 (White)
	Lubrificare con GRASSO Molykote G807 Lubricate with Molykote G807 GREASE

Characteristics and descriptions are not binding. - Données descriptives et illustrations n'engagement pas le constructeur. - Angaben, Beschreibungen, und Illustrationen sind nicht verbindlich. - Notas y ilustraciones no son empeltivas. - Os dados, descrições e ilustrações são fornecidos a título informativo e não comprometem o fabricante. - Dati, descrizioni ed illustrazioni sono forniti a titolo indicativo e non impegnativo.



ATTENTION: This manual must be read before beginning installation of the unit.
ATTENTION: Ce livret doit être lu avant d'installer et d'employer le produit.
A CH TUNG: Das vorliegende Handbuch ist vor der Installation und dem Gebrauch des Produkts aufmerksam zu lesen.
ATENCIÓN: Este manual debe ser leído antes de proceder a la instalación y uso de producto.
ATENÇÃO: Este manual deve ser lido antes de proceder à instalação e ao uso do produto.
ATTENZIONE: Il presente libretto va letto prima di procedere all'installazione ed uso del prodotto.

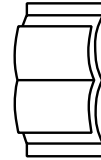

ANNOVI REVERBERI
The Power of Experience

Member of



ANNOVI REVERBERI S.p.A.

Via M.L. King, 3 - 41122 Modena (Italy)
Tel. (+39) 059.414.411 - Telefax (+39) 059.253.505
E-Mail Italia: agricoltura.it@annovireverberi.it
E-Mail export: agriculture.export@annovireverberi.it

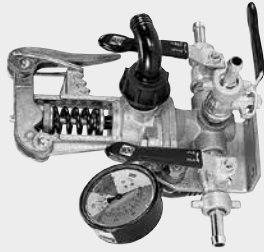

GS 20 S



VDR 20 S



RM 20 S

Control Units**Groupes de commande****Bedienungsarmaturen****Grupo de mando****Gruppi comando****VDR 20 S**

TECHNICAL DATA / DONNÉES TECHNIQUES / TECHNISCHE ANGABEN
CARACTERÍSTICAS TÉCNICAS / CARACTERÍSTICAS TÉCNICAS / CARATTERISTICHE TECNICHE

CONTROL UNITS GROUPES DE COMMANDE BEDIENUNGSARMATUREN GRUPOS DE MANDO GRUPPI COMANDO	OUTPUT DEBIT LEISTUNG CAUDAL PORTATA		PRESSURE PRESSION DRUCK PRESIÓN PRESSIONE		N. VALVES N. ROBINETS N. VENTILEN VÁLVULAS N. RUBINETTI		WEIGHT POIDS GEWICHT PESO PESO	
	l/min	gpm (US)	bar	psi			kg	
GS 20 S	50	13,2	20	290	3		1,6	
RM 20 S	50	13,2	20	290	3		1,6	
VDR 20 S	130	34,3	20	290	4		2,2	

62864

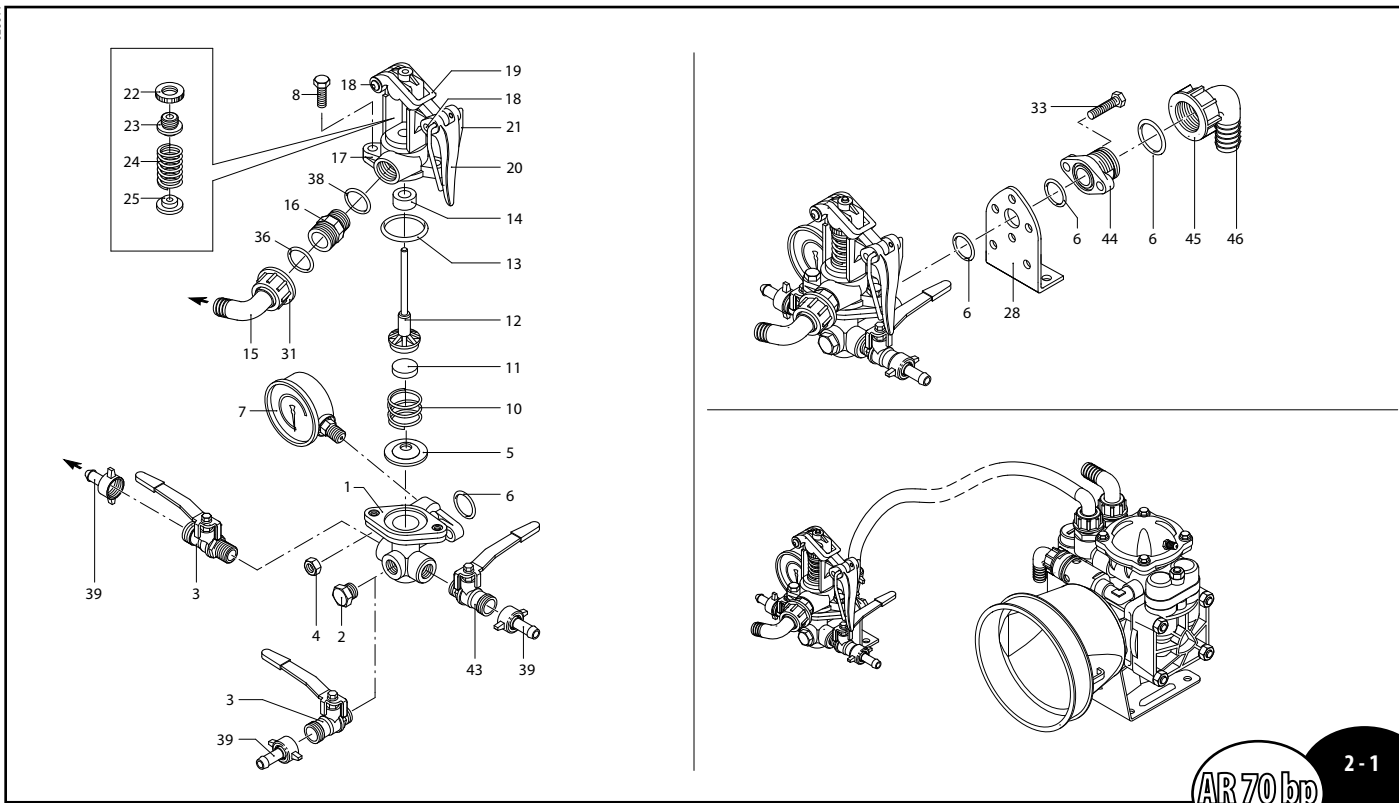

UN970177-LJ

Pos	Cod.	Descrizione	Description	Q.ty	Note
1	620220	Gruppo comando	Control unit	1	
2	130171	Tappo	Plug	1	C ₂₀
3	130491	Rubinetto	Cock	2	
4	390270	Dado	Nut	2	C ₂₀
5	450110	Sede	Seat	1	
6	550350	Guarnizione OR	O-ring	3	
7	391240	Manometro	Pressure gauge	1	0-24 bar
8	180370	Vite	Screw	2	C ₂₀
10	320420	Molla	Spring	1	
11	110121	Pastiglia	Plug	1	Vulkolan
11	110120	Pastiglia	Plug	1	Gomma
11	110122	Pastiglia	Plug	1	Viton
12	320433	Funghetto completo	Stem	1	
12	320511	Guarnizione OR	O-ring	1	
13	390140	Guarnizione	Gasket	1	Gomma
14	390141	Guarnizione	Gasket	1	Viton
15	550460	Curva	Elbow	1	
16	550440	Raccordo	Fitting	1	
17	320410	Castello valvola	Body valve	1	
18	320480	Perno	Hub pin	2	
19	320460	Forcella	Fork	1	
20	320470	Leva	Lever	1	
21	320490	Supporto	Support	1	
22	320450	Piattello	Wobble plate	1	
23	320440	Ghiera	Ring nut	1	
24	550840	Molla	Spring	1	
25	230120	Piattello	Wobble plate	1	
28	320406	Staffa	Bracket	1	
31	550450	Girello	Ring nut	1	
33	160660	Vite	Screw	2	C ₁₀
36	880830	Guarnizione OR	O-ring	1	
38	180101	Guarnizione OR	O-ring	1	
39	110131	Girello	Ring nut	3	
43	130492	Rubinetto	Cock	1	
44	550390	Flangia	Flange	1	
45	550242	Girello	Ring nut	1	
46	550380	Curva	Elbow	1	

sp_gs20s.pdf

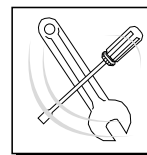
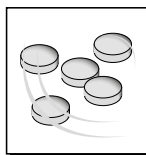

KIT 1922 Pastiglie Vulkolan Vulkolan valve seats			
KIT 1921 Pastiglie gomma Buna valve seats			
Pos.	Q.ty	Pos.	Q.ty
11			
5			

KIT 1925 Pronto intervento Maintenance repair			
Pos.	Q.ty	Pos.	Q.ty
5	1		
10	1		
11	1		
12	1		
13	1		
14	1		

1158600

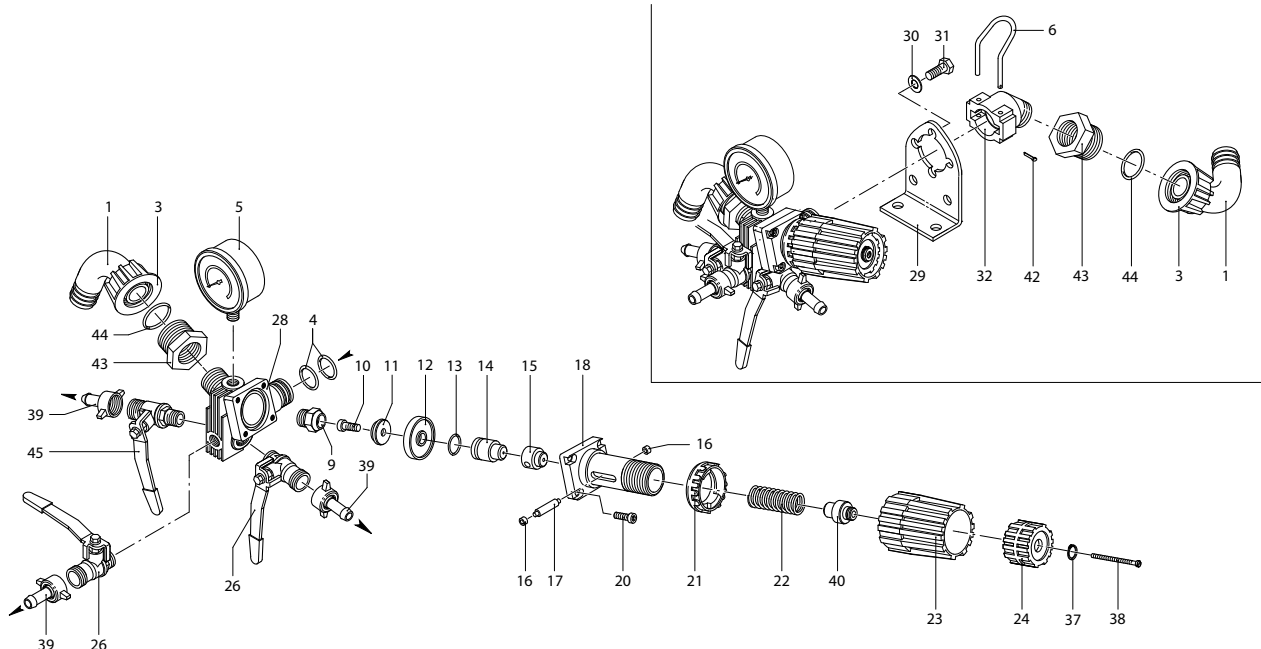

3 - 1

UN970176-LJ

Pos	Cod.	Descrizione	Description	Q.ty	Note
1	550370	Curva	Ø25	2	
3	550242	Girello	1" G	2	
4	390180	Guarnizione OR	Ø18,72x2,62	2	▶
5	391240	Manometro	Ø63	1	0-24 bar
6	1040690	Forcella	Fork	1	
9	1150520	Sede	Seat	1	⊕ C ₂₀
10	680560	Vite	TCEI M6x16	1	Inox ⊕ C ₁₀
11	1040640	Valvola	Valve	1	Inox
12	1040631	Membrana	Diaphragm	1	Desmopan
12	1040630	Membrana	Diaphragm	1	NBR
13	880830	Guarnizione OR	Ø15,54x2,62	1	▶
14	1040621	Pistone	Piston	1	
15	1150560	Distanziale	Spacer	1	
16	1150600	Anello	Ring	2	
17	1150540	Perno	Hub pin	1	
18	1150510	Corpo superiore	Body	1	☒
20	780330	Vite	TCEI M6x20	4	C ₁₀
21	1150530	Ghiera	Ring nut	1	☒
22	1150680	Molla	Spring	1	☒
23	1150550	Manopola	Knob	1	Rossa
24	1150570	Ghiera	Ring nut	1	
26	130491	Rubinetto	3/8" G - 1/2" G M-M DX	2	⊕ C ₂₀
28	1150500	Corpo valvola	Valve body	1	
29	1150590	Staffa	Bracket	1	
30	390311	Rondella	Washer	2	
31	180431	Vite	TE M8x16	2	C ₂₀
32	1040770	Raccordo	Fitting	1	
37	480550	Anello	seeger Øe 12	1	
38	1150650	Vite	TCTC M3x60	1	⊕ C ₅
39	110131	Girello	1/2"	3	
40	1150660	Distanziale	Spacer	1	
42	1040950	Copiglia	Split pin	1	
43	800720	Raccordo	3/4" G - 1" GF-M	2	
44	550350	Guarnizione OR	Ø23,81x2,62	2	▶
45	130492	Rubinetto	3/8" G - 1/2" G M-M SX	1	⊕ C ₂₀

sp_rm20s.pdf

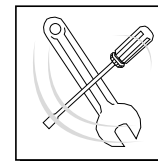
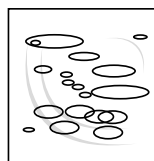

KIT 2382 OR O-Rings				KIT 2383 Pronto intervento Maintenance repair			
Pos.	Q.ty	Pos.	Q.ty	Pos.	Q.ty	Pos.	Q.ty
4	2			4	2	23	1
13	1			6	1	24	1
44	2			9	1	37	1
				11	1	38	1
				12	1	40	1
				13	1	42	1
				15	1	44	2
				17	1		
				21	1		
				22	1		

VDR 20 S - cod.954

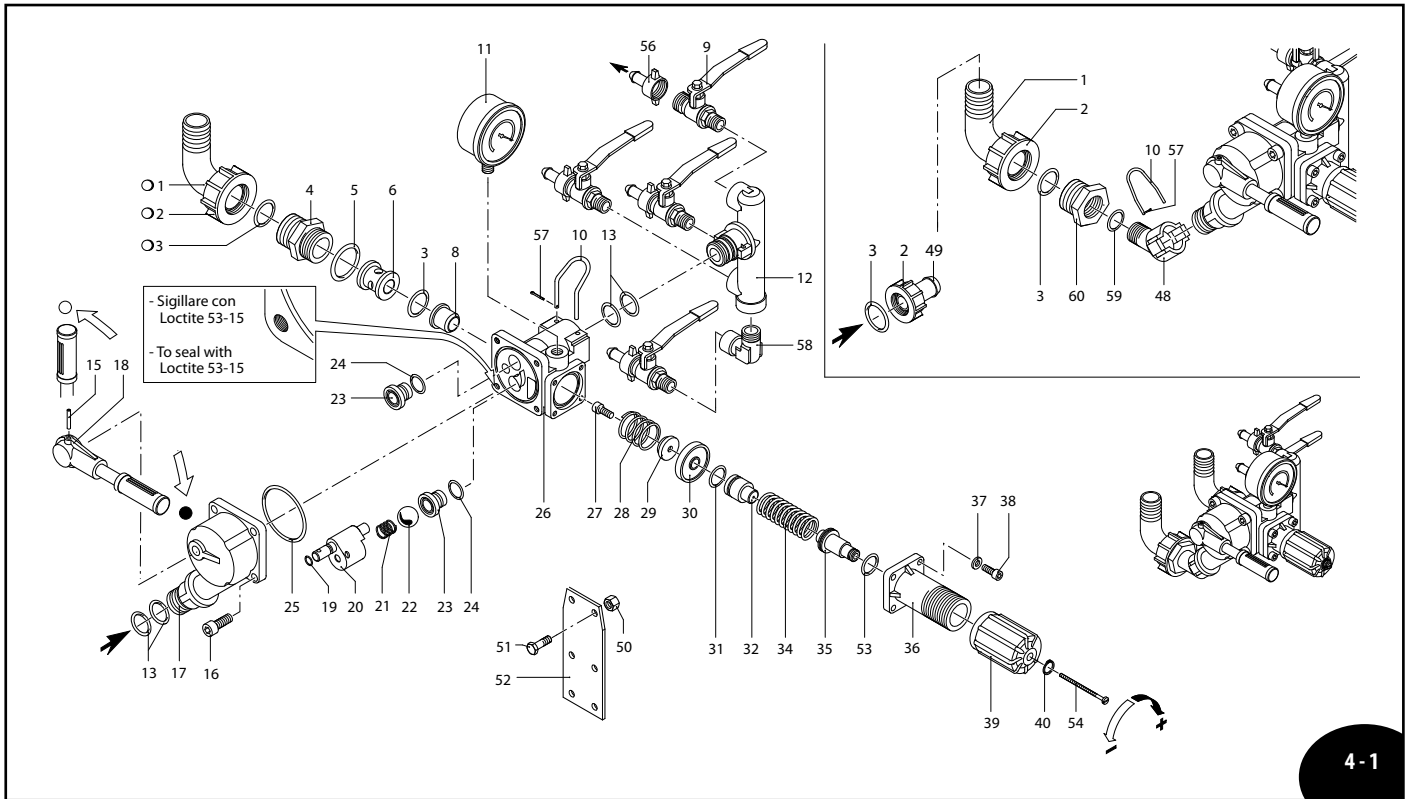

UN970176-LJ

Pos	Cod.	Descrizione	Description	Q.ty	Note
1	550370	Curva Ø 25	Elbow	3	
2	550242	Girello 1" G	Ring nut	3	
3	550350	Guarnizione OR Ø 23,81x2,62	O-ring	4	
4	1040780	Raccordo 1" G M-M	Fitting	1	
5	550040	Guarnizione OR Ø 26,65x2,62	O-ring	1	☒
6	1040670	Distanziale	Spacer	1	
8	1040660	Sede	Seat	1	Inox
9	130491	Rubinetto 3/8" G - 1/2" G M-M DX	Cock	4	☑ C ₂₀
10	1040690	Forcella	Fork	2	
11	391240	Manometro	Pressure gauge	1	☑
12	1040680	Corpo	Body	1	
13	390180	Guarnizione OR Ø 18,72x2,62	O-ring	4	☒
15	1040820	Spina	Pin	1	
16	180030	Vite TCEI M8x20	Screw	4	C ₂₀ (1)
17	1040720	Corpo distributore	Body	1	
18	1040730	Manopola	Knob	1	
19	1080200	Guarnizione OR Ø 5,6x2,2	O-ring	1	▶
20	1040700	Perno	Hub pin	1	☒
21	850680	Molla	Spring	1	☒
22	850660	Sfera	Ball	1	Inox
23	850650	Sede	Seat	2	☒
24	740290	Guarnizione OR Ø 14x1,78	O-ring	2	▶
25	1040710	Guarnizione OR Ø 56x2	O-ring	1	▶
26	1040600	Corpo	Body	1	
27	680560	Vite TCEI M6x16	Screw	1	Inox ☑ C ₁₀
28	1040650	Molla	Spring	1	☒
29	1040640	Valvola	Valve	1	Inox
30	1040630	Membrana	Diaphragm	1	Desmopan
30	1040631	Membrana	Diaphragm	1	NBR
31	880833	Guarnizione OR Ø 15,54x2,62	O-ring	1	▶
32	1040622	Pistone	Piston	1	☒
34	1041170	Molla	Spring	1	☒
35	394770	Perno	Hub pin	1	☒
36	1040610	Corpo guida molla	Body	1	
37	550331	Rondella	Washer	4	
38	1040370	Vite TCEI M6x22	Screw	4	
39	394790	Manopola	Knob	1	C ₁₀
40	480550	Anello seeger Øe 12	Ring	1	
48	1040770	Raccordo	Fitting	1	
49	550210	Tubo Ø 25	Pipe	1	
50	390270	Dado M8	Nut	2	C ₂₀

sp_valv20s.pdf

Pos	Cod.	Descrizione	Description	Q.ty	Note
51	180370	Vite TE M8x25	Screw	2	
52	850690	Staffa	Bracket	1	
53	770130	Guarnizione OR Ø 20,35x1,78	O-ring	1	▶ C _{1,4}
54	1150650	Vite TCTC M3x60	Screw	1	☑
56	110131	Girello 1/2"	Ring nut	4	
57	1040950	Copiglia	Split pin	2	
58	900210	Raccordo 3/8" G M-F	Fitting	1	
59	550040	Guarnizione OR Ø 26,62x2,62	O-ring	1	▶
60	800720	Raccordo 3/4" G - 1" G F-M	Fitting	1	

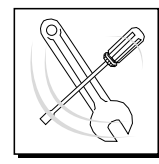
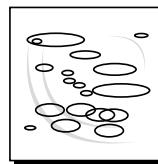

KIT 2384 OR O-Rings			
Pos.	Q.ty	Pos.	Q.ty
3	3		
5	1		
13	4		
19	1		
24	2		
25	1		
31	1		
53	1		
59	1		

KIT 2385 Pronto intervento Maintenance repair			
Pos.	Q.ty	Pos.	Q.ty
3	3	25	1
5	1	28	1
10	2	29	1
13	4	30	1
15	1	31	1
19	1	39	1
21	1	53	1
22	1	57	2
23	2		
24	2		

(1) Solo vite con foro passante

MI99372

1048608